

Distancia entre pilares = 5000

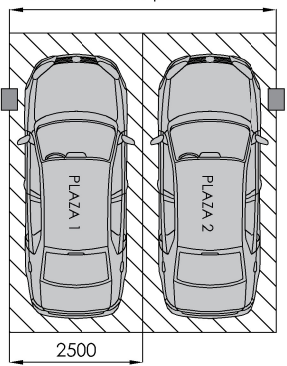

Vuelo para 2 pórticos = 583,5 mm.

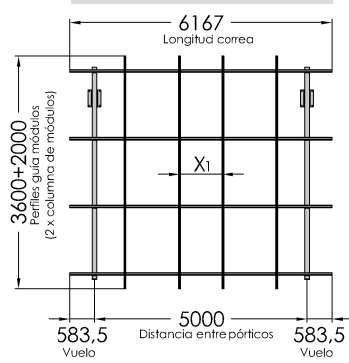

Vuelo para más de 2 pórticos = 1169 mm.

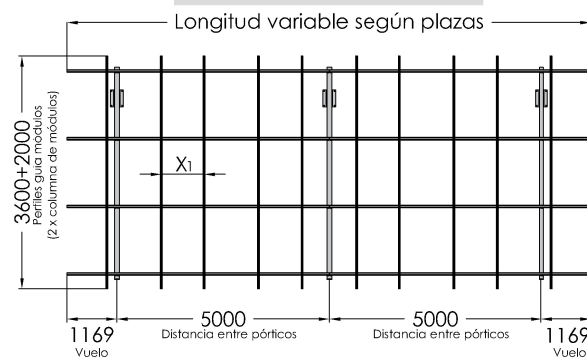

X_i - La distancia entre perfiles guía vendrá determinado por el tipo de módulo

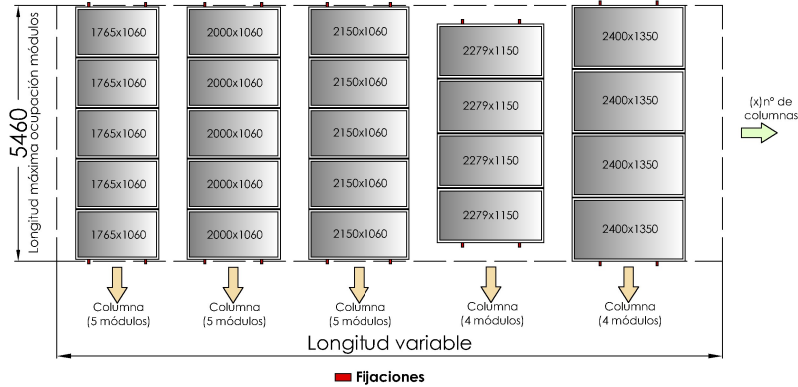

n° plazas aparcamiento	Ocupación total	Hasta 1765x1060		Hasta 2000x1060		Hasta 2150x1060		Hasta 2279x1150		Hasta 2400x1350	
		N° de módulos por columna	N° de columnas	N° de módulos por columna	N° de columnas	N° de módulos por columna	N° de columnas	N° de módulos por columna	N° de columnas	N° de módulos por columna	N° de columnas
2	6167	5	3	5	3	5	2	4	2	4	2
4	12338	5	6	5	6	5	5	4	5	4	5
6	17338	5	9	5	8	5	8	4	7	4	7
8	22338	5	12	5	11	5	10	4	9	4	9
10	27338	5	15	5	13	5	12	4	11	4	11
12	32338	5	18	5	16	5	14	4	14	4	13
14	37338	5	20	5	18	5	17	4	16	4	15
16	42338	5	23	5	20	5	19	4	18	4	17
18	47338	5	26	5	23	5	21	4	20	4	19
20	52338	5	29	5	25	5	24	4	22	4	21

- Tamaño plaza: 2,50x5,60 m
- Disponible desde 2 plazas hasta 20 plazas.
- Disposición de los módulos en horizontal.
- Inclinação estándar 5°.
- Altura libre 2.20 m

CARGAS MÁXIMAS ADMISIBLES

OPCIÓN 1
Viento 110 Km/h + Nieve 40 Kg/m²

OPCIÓN 2
Viento 130 Km/h + Nieve 20 Kg/m²

Materiales:
Pilares, vigas y correas en acero galvanizado en caliente por inmersión. Calidad del acero S275
Perfilería de aluminio EN AW 6005A T6
Tornillería de acero inoxidable A2-70

Acabados:
Pilares, vigas y correas en acero galvanizado en caliente por inmersión

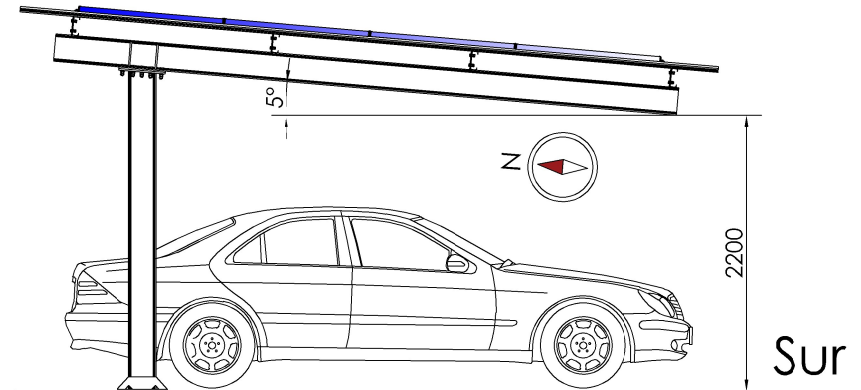

Se requiere cimentación previa a la instalación de la marquesina.
Tornillería de anclaje a suelo no incluida.



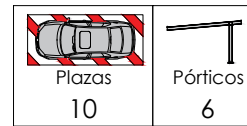
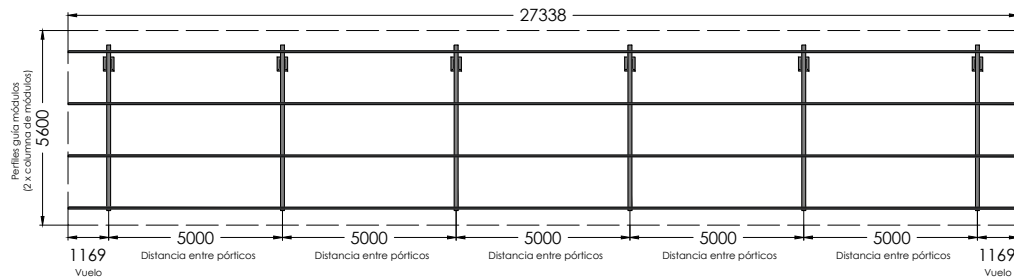
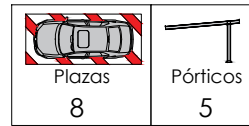
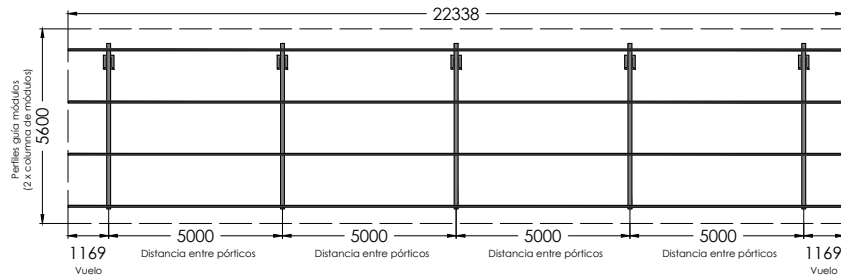
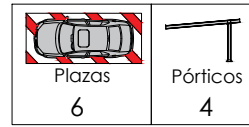
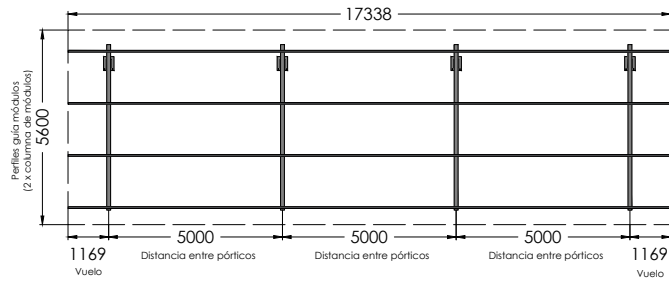
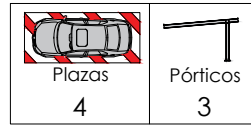
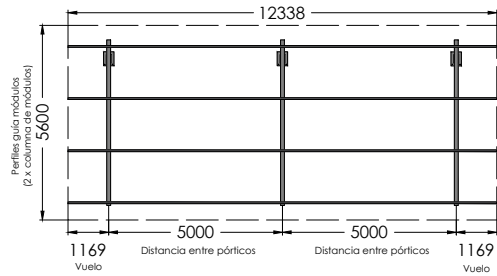
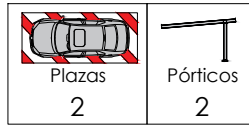
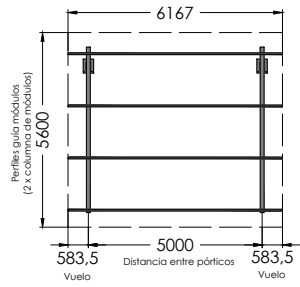

MARQUESINA APARCAMIENTO

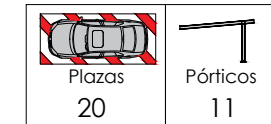
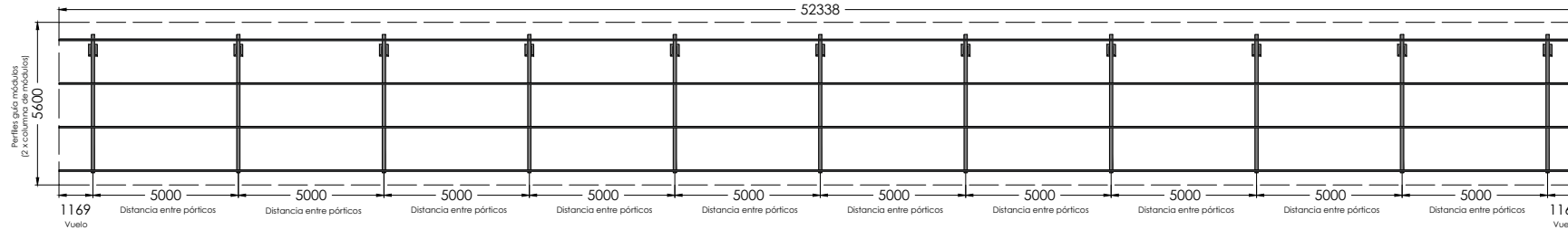
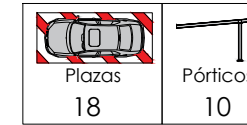
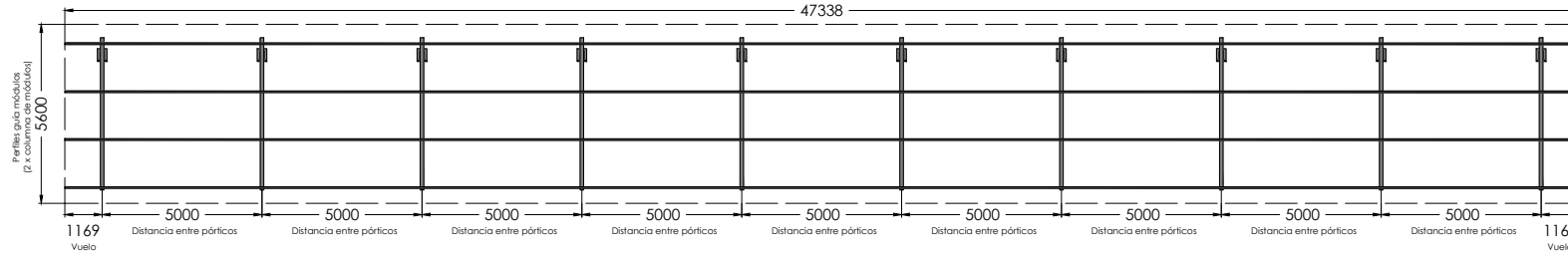
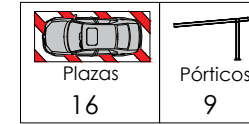
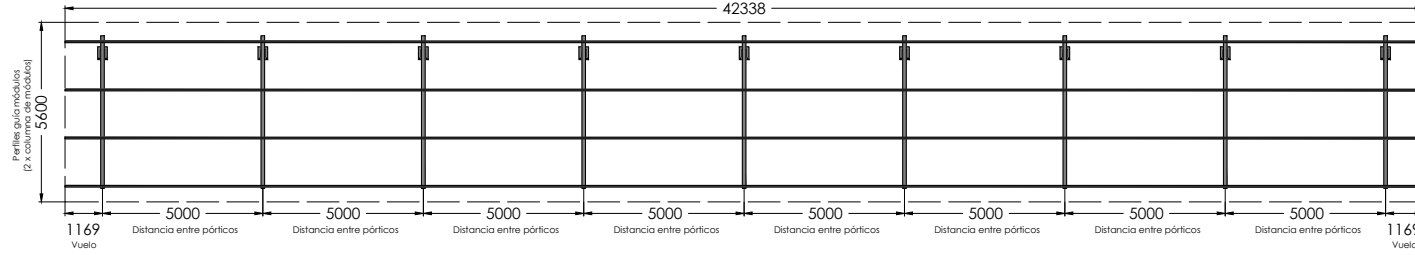
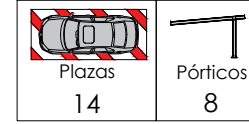
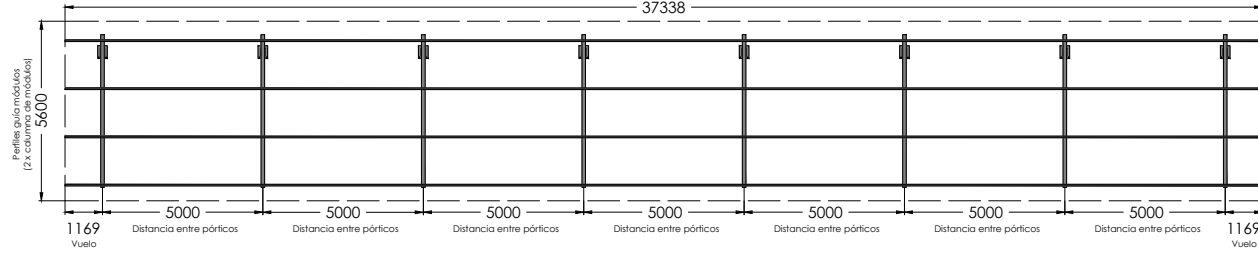
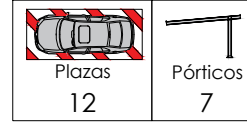
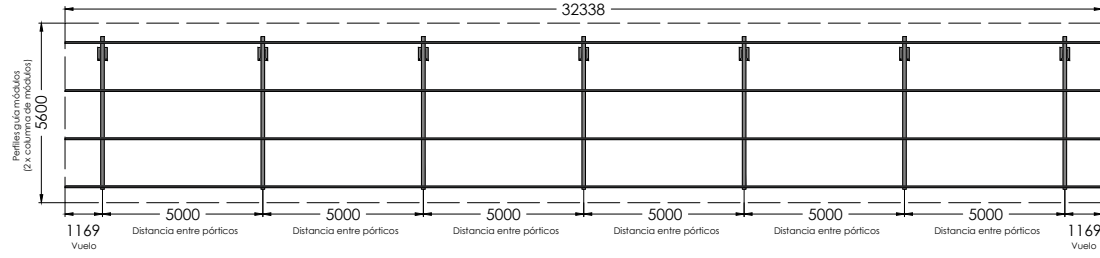

ZAPATA EXTREMOS

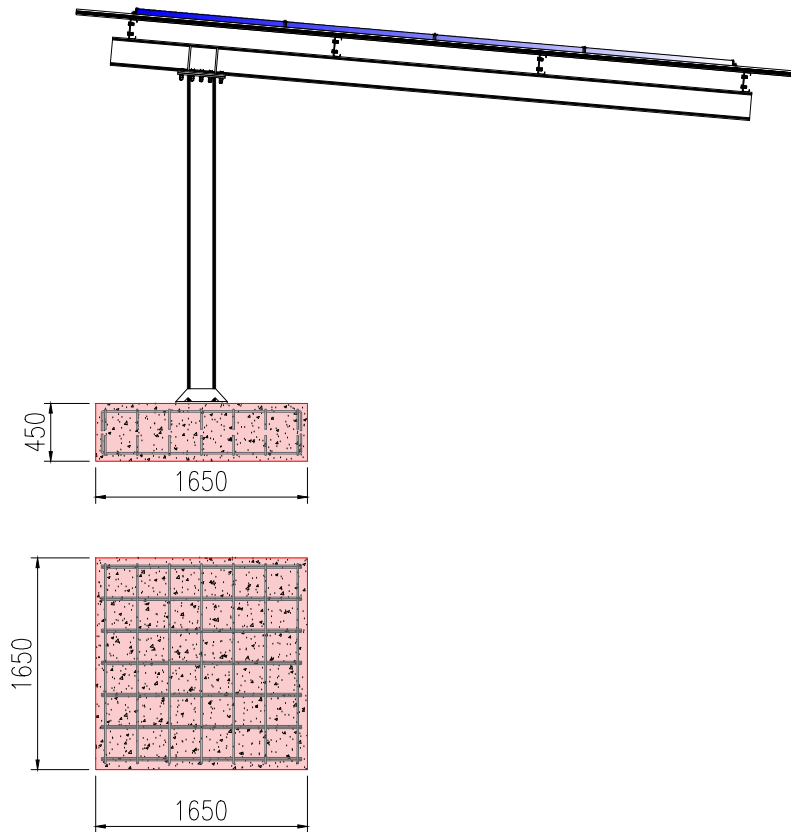

ZAPATA CENTRAL

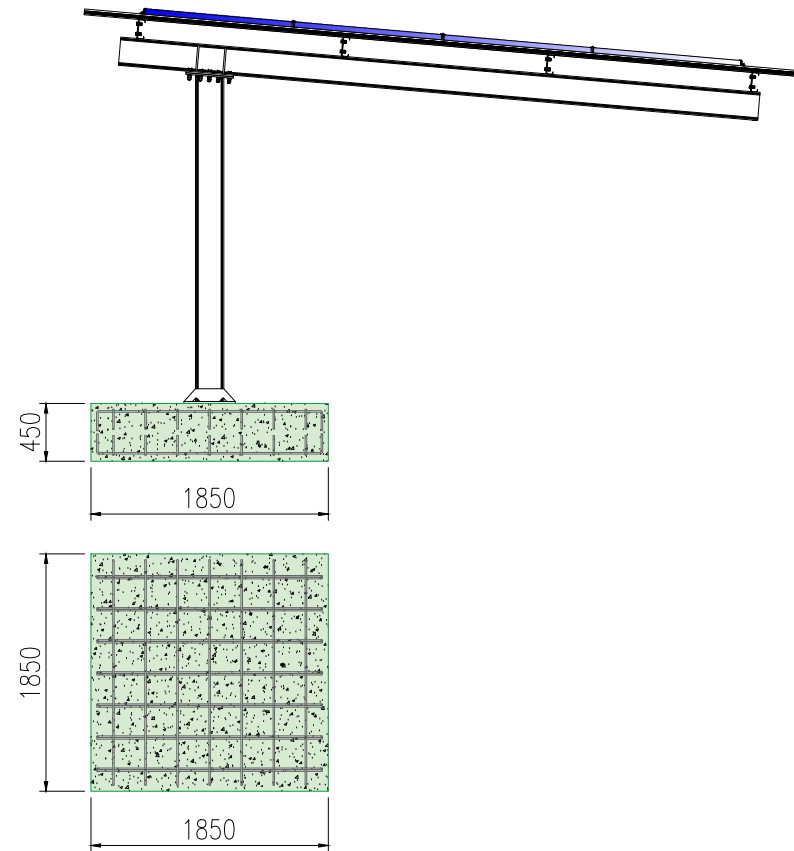

PR2

SUNFER

CIMENTACIÓN

MARQUESINA APARCAMIENTO

CARACTERÍSTICAS

- Resistencia del hormigón = HA-25
- Dimensiones de la zapata = 1650x1650x450 mm
- Armadura = Acero corrugado B400S
- Armadura superior e inferior Ø12 cada 250mm
- Anclaje (no incluido): Pernos de acero con gancho 6 uds M16 long.= 300mm enterrados +100mm exterior
- *Tener en cuenta placa y mortero de nivelación

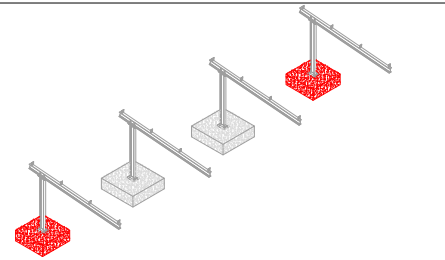

CARACTERÍSTICAS

- Resistencia del hormigón = HA-25
- Dimensiones de la zapata = 1850x1850x450 mm
- Armadura = Acero corrugado B400S
- Armadura superior e inferior Ø12 cada 250mm
- Anclaje (no incluido): Pernos de acero con gancho 6 uds M16 long.= 300mm enterrados +100mm exterior
- *Tener en cuenta placa y mortero de nivelación

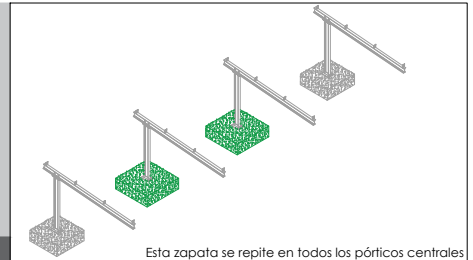

Esta zapata se repite en todos los pórticos centrales

* Ver detalle tornillería de anclaje en página 2

- Velocidad = 110 Km/h

Se ha calculado para una tensión admisible del terreno de 3Kg/cm2



La DF deberá comprobar mediante un estudio geotécnico que la tensión admisible del terreno sea igual o superior a la de diseño.



ZAPATA EXTREMOS

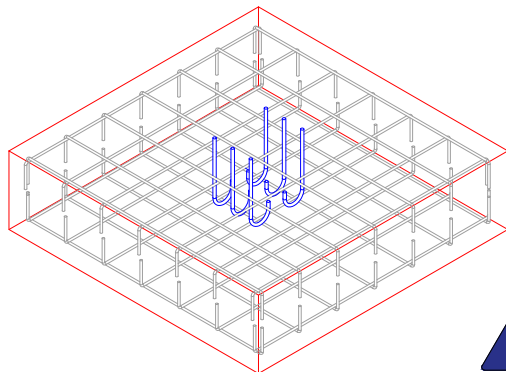
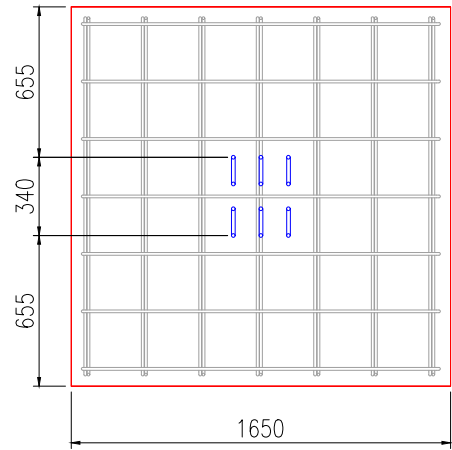
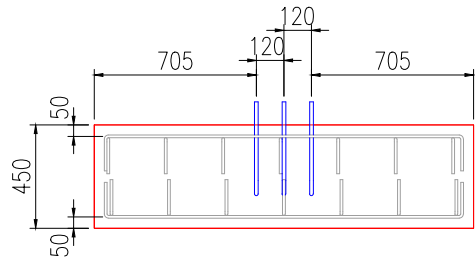

ZAPATA CENTRAL

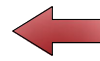
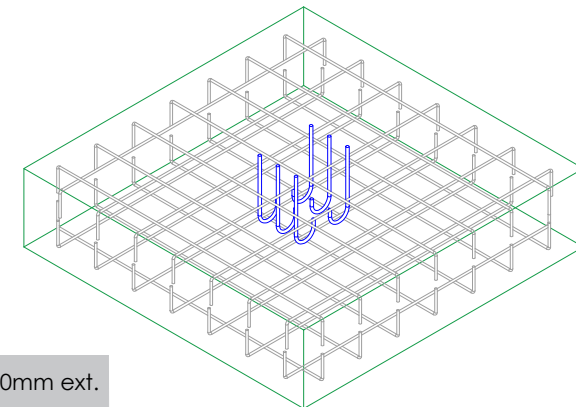
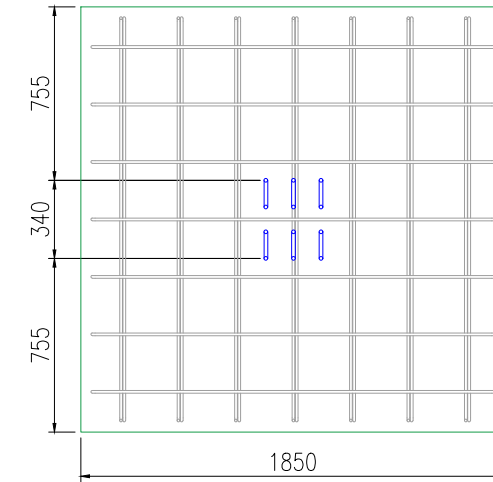
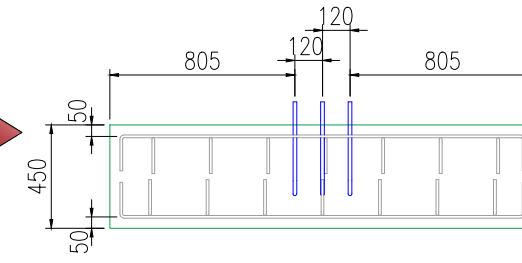

Desplazar la armadura superior para que no intersece con el anclaje.
El anclaje debe quedar centrado respecto a la zapata.

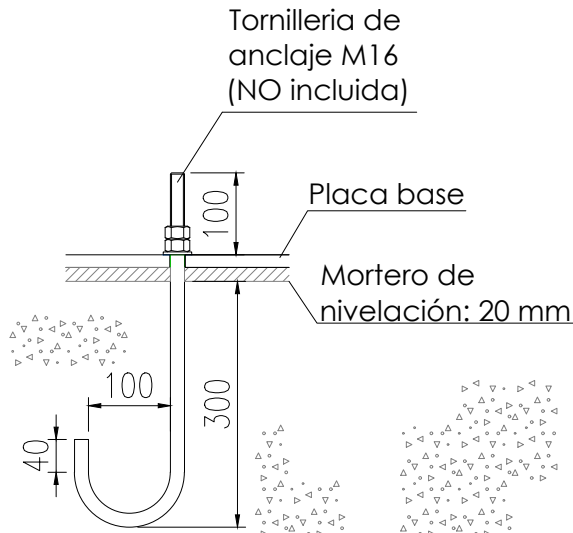
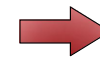

Hormigón: HA-25, Yc=1.5

Orientar anclaje al interior de la zapata
(NO incluidos)



Tipo de anclaje: Perno de acero con gancho M16 longitud 300mm int.+100mm ext.
Si el tornillo es cincado, la calidad mínima debe ser de 8.8.
Si el tornillo es inoxidable, la calidad mínima debe ser A2-70.